

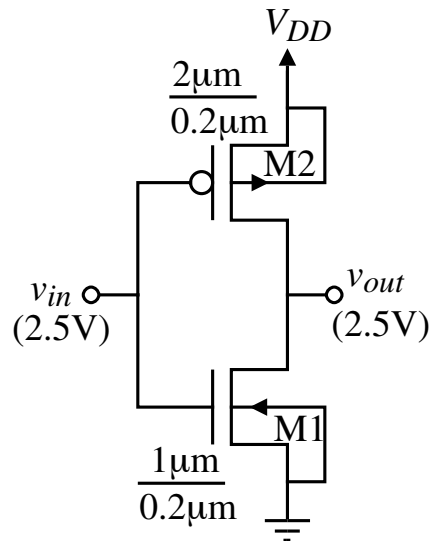







### Layout of a CMOS Inverter



Blue	Green	Black	Red	Orange	Brown	White
						
n <sup>+</sup>	p <sup>+</sup>	Metal	Poly	p-well	n-well	n-substrate

